

49" LCD Video Wall Displays



Go big using our 4K compatible video wall panels, with automatic tiling to fill any space

4K Daisy Chain Tiling



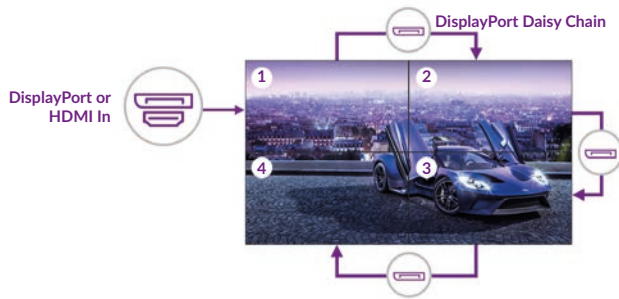





These displays feature DisplayPort in and outputs, allowing you to daisy chain up to a 4K signal once connected. The integrated matrix processor significantly cuts the cost of external hardware, installation and maintenance, providing a cost-effective solution while still maximizing video quality with an immersive viewing experience.



Fantastic Colours

To keep colour variation between panels to a minimum, colours are pre-calibrated, with the option to be adjusted once installed. The LED backlight technology also offers an incredible contrast ratio performance with deeper blacks and brighter whites, creating an enhanced colour intensity.



-  Seamless Video Wall
-  Eco Friendly Power Timer
-  Temperature Control
-  RS-232 Control
-  Landscape/Portrait Orientation
-  Easy Install Handles
-  Slim and Lightweight Design
-  Reliable Displays
-  Anti-Glare Panel

Other Features

Super Narrow Bezel (3.5mm)

With a total screen-to-screen bezel size of 3.5mm these displays are ideal as part of a virtually seamless LCD video wall – providing you with an eye catching, and content focused display. Their super narrow bezel allows you to build video walls of any size.

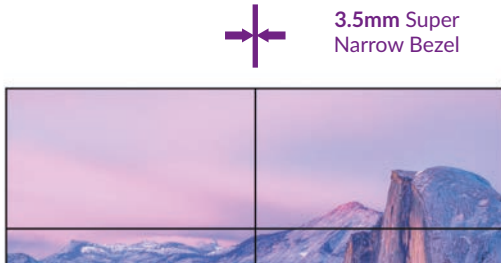

500cd/m² IPS Panel

With a brightness of 500cd/m² that ensures high visibility even under bright ambient light, these commercial grade IPS panels are designed to achieve ultimate lifelike colour with a remarkable viewing angle of 178° in both landscape and portrait.



4K Compatible Video Wall

With large video walls content resolution is very important. If you have a 4K source you can achieve extraordinary image quality and ultra-high definition without the need to scale devices or purchase any external matrix controller.

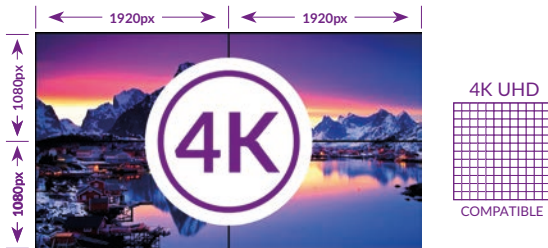

Multiple Inputs

Featuring HDMI and DisplayPort inputs, these displays are ideal whether the screens are being used individually, as part of a video wall using the internal video matrix processor or being run from an external matrix controller.

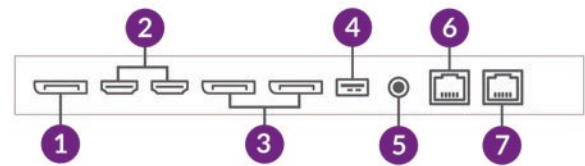

1. DisplayPort Out
2. HDMI In x2
3. DisplayPort In x2
4. USB (Firmware Updates)
5. IR Extension
6. RS-232 In
7. RS-232 Out

24/7 Commercial Grade

These displays use a commercial grade LCD panel and LED components. They have the ability to be in constant use 24/7 for over 70,000 hours and have no external buttons or controls to avoid tampering.



Resistant to Blackening

These displays feature a fanless cooling system that keeps panels and other internal components at the optimum working temperature. This not only provides resistance to blackening but it also ensures a long and reliable life for your screens.



Eco Friendly Display

Designed to perform at high quality levels while operating at a lower energy usage, these displays feature LED backlight technology that reduces power consumption by around 30%. They also feature an eco-friendly power timer that recognises your input signal so they automatically power off and on and are only in use when needed.



Optional External Network Upgrade

With our Cloud Network Media Player, you can connect your video wall via Wi-Fi, LAN or 4G, and then remotely update it over the internet. Additionally, you can manage the content displayed with our user-friendly content management system.

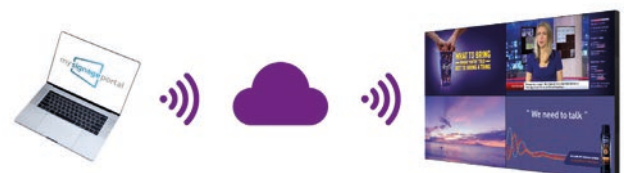

Key Features

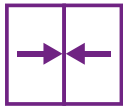

3.5MM SUPER NARROW BEZEL



ULTRA RESISTANT TO BLACKENING DEFECT



LANDSCAPE OR PORTRAIT ORIENTATION



SLIM PROFILE



ANTI-GLARE IPS PANEL

24/7 COMMERCIAL GRADE

SILENT RUNNING

VESA COMPATIBLE MOUNTING



4K DAISY CHAIN TILING

RANGE OF AV INPUTS

EASY INSTALLATION HANDLES

VIVID COLOUR DISPLAY

Specification Table

		49 Inch
Panel	Resolution	1920x1080
	Bezel Size	Bottom/right: 2.34, Top/left: 1.16
	Display Area (mm)	1074x604.3
	Aspect Ratio	16:9
	Brightness (cd/m ²)	500
	Colour	16.7M
	Colour Temperature	10,000K
	Viewing Angle	178°
	Contrast Ratio	1,300:1
AV Inputs/Outputs	Inputs	DisplayPort In, HDMI In x2, RS-232 In
	Outputs	DisplayPort Out, RS-232 Out
Power	Power Consumption (W)	<120W
	Input Voltage	AC 100V ~ 240V(50/60Hz)
	Power Management	VESA DPMS
Mechanical	Unit Size (WxHxD mm)	1077.5x607.8x101.6
	Package Size (WxHxD mm)	1210x730x210
	VESA Holes (mm)	600x400 M6
	Net Weight (kg)	14.4
	Gross Weight (kg)	20.1
Environmental	Operating Temperature	0 °C to 50 °C
	Storage Temperature	-30°C to 60°C
	Working Pressure	800-1114 hPa (Altitude:0-2,000m)
Accessories	Included	1.5m DisplayPort Cable, LAN Cable and IR Sensor, Remote Control, 1.5m Power Cable, User Manual
	Optional	Network or Standalone Media Player, Touch Screen Frame
Warranty	Warranty Period	3 Year Warranty
	Technical Support	Lifetime

Errors and omissions excepted



Technical Drawing

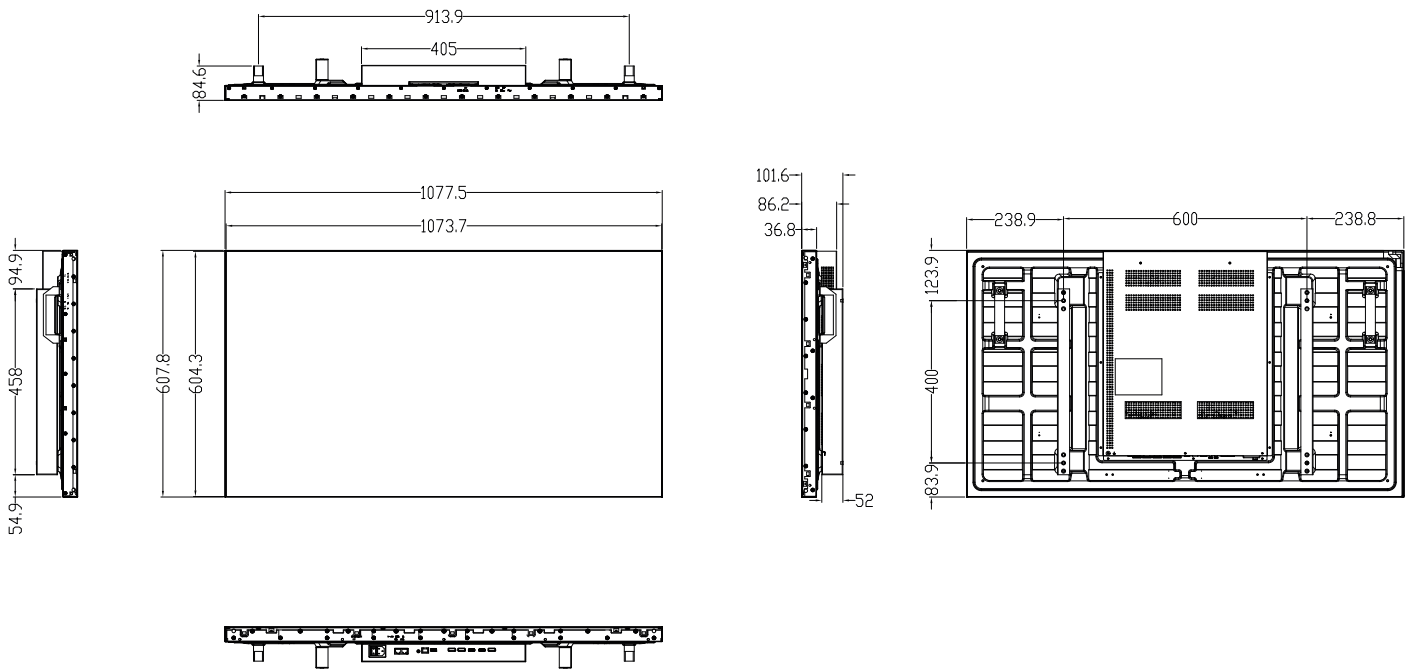

Why Choose Our Commercial Display Solutions?



Lifetime Technical Support

From the moment you receive your product, throughout the duration of your warranty and even after your warranty has expired we are here to support you. If you require any assistance setting up or using your product, or have any problems at all, we can provide free technical support via telephone and email.



On-site Support and Maintenance*

If needed, we can provide an installation service for any of our products. We can also set up service-level agreements for larger projects that require maintenance contracts.



Extended Warranty*

All of our commercial display products come with a 3 year commercial warranty as standard but if you want to extend this you can upgrade this to cover a 5 year period at point of purchase.



Training

As well as providing free remote CMS training sessions and webinars we can also visit you to deliver bespoke training for our software and hardware*.



Advanced Replacements†

Should your display suffer from any kind of hardware failure during the warranty period we will send you an advanced replacement and arrange for your old display to be collected, free of charge. This ensures no downtime where you are without a screen.



Custom Product Testing & Configuration

If you need us to test third party software or a website, or configure your screen in a particular way before it is dispatched (e.g. in a particular orientation or network mode), we can do so to make your life easier.



3D Rendering

Want to know how a particular screen will look once installed? Send us a photo of the location and we will create a 3D rendering of any screen in situ to help you to visualise how amazing it will look.



Logistics Support

We hold more stock in our UK warehouse than any other manufacturer so we can help you meet tight deadlines. For last minute orders we can also offer special express or morning delivery options*. We also carry out UK based quality control checks on every display before it leaves our warehouse.



Project Support

If you need to loan a sample unit to test we'd be more than happy to arrange this. We can also provide a rental service for temporary projects*.



Customisation*

Your display can be customised to suit your requirements by adding your logo or printed graphics or even tailoring the colour of a display. We can also carry out hardware modifications to existing products or manufacture bespoke solutions for special projects.



Extras*

As well as being able to provide accessories and add-ons, such as extra remote controls, NUC PCs and video wall controllers, we can also supply custom made flight cases which are great if a display needs to be moved safely from place to place.

†UK mainland only

*These particular services may incur additional charges